

# RCJ Rescue Line Rules

## U12

This rule is for the RoboCup Singapore Open 2026. It is produced by the RoboCup Singapore Rescue Line Technical Committee based on the Based on RoboCup Junior Rescue Line Rules for 2025

## Scenario

The land is too dangerous for humans to reach the victims. Your team has been given a difficult task. The robot must be able to carry out a rescue mission in a fully autonomous mode with no human assistance. The robot must be durable and intelligent enough to navigate treacherous terrain with hills, uneven land, and rubble without getting stuck. When the robot reaches the victims, it has to gently and carefully transport each one to the safe evacuation point where humans can take over the rescue. The robot should exit the evacuation zone after a successful rescue to continue its mission throughout the disaster scene until it leaves the site. Time and technical skills are essential! Come prepared to be the most successful rescue team.

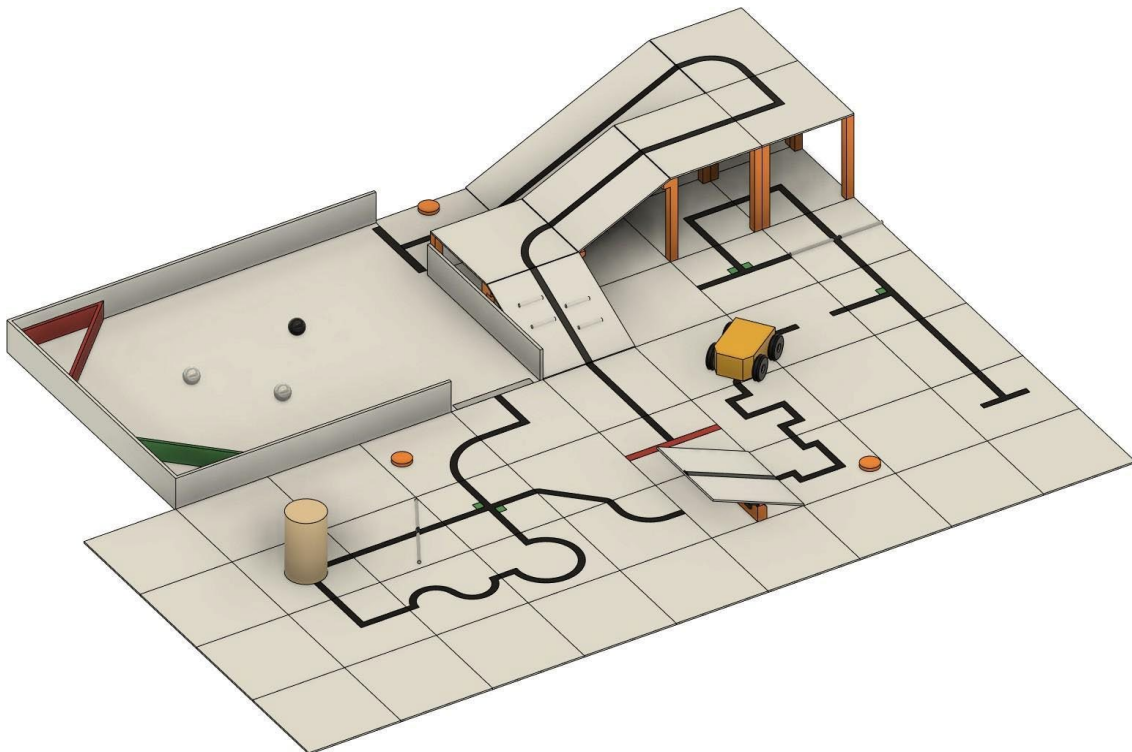

## Summary

An autonomous robot should follow a black line while overcoming problems in a modular field formed by tiles with different patterns. The floor is white, and the tiles are on different levels connected with ramps.

Teams are not allowed to give their robot any information in advance about the field as the robot is supposed to recognize the area by itself. The robot earns points as follows:

- 10 points for following the correct path on a tile at an intersection or a dead end.
- 20 points for navigating through a seesaw tile.
- 20 points for overcoming each obstacle (bricks, blocks, weights, and other large, heavy items). A robot is expected to navigate various obstacles.
- 10 points for reacquiring the line after a tile with one or more gaps.
- 10 points for each successfully navigated ramp tile.
- 10 points for negotiating a tile with one or more speed bumps.

If the robot gets stuck in the field, it can be restarted at the last visited checkpoint. The robot will earn points when it reaches new checkpoints. Somewhere on the path, there will be a rectangular zone with walls (the evacuation zone). The evacuation zone is delimited in the entrance with a reflective silver tape strip attached to the floor and the exit with a strip of black tape.

Once in the evacuation zone, the robot should locate and transport the victims to the designated evacuation points. The victims are represented by spheres with an off-center center of mass of 4 to 5 cm in diameter. The live victims are reflective silver which is electrically conductive, and the dead victims are black, which is not electrically conductive.

The team can earn multipliers for victim evacuations depending on the rescue order. Be prepared to face obstacles, speed bumps, and debris in the evacuation zone. Still, the robot will not score points by negotiating these difficulties here. The robot should then exit the evacuation zone and follow the line until the goal tile of the course is reached.

Contents

Scenario .....	1
Summary .....	2
Contents .....	3
1. RoboCup General Rules .....	5
1.1. Team requirements .....	5
1.1.1. Team Size .....	5
1.1.2. Age Requirements.....	5
1.1.3. Team Members .....	5
1.2. Robot Requirements .....	5
1.2.1. Robot Communication .....	5
1.2.2. Safety and Power Requirements .....	6
1.3. Documentation and Sharing requirements .....	6
1.3.1. Technical Description (See League Documentation) .....	6
1.3.2. Sharing Team Resources .....	6
1.3.3. Plagiarism Guidelines .....	7
1.4. Spirit and Behavior .....	7
1.4.1. Behavior.....	7
1.4.2. Mentoring, Sponsorships and Component Reuse.....	7
1.4.3. Onsite help .....	7
1.4.4. Violations .....	7
2. Code of Conduct.....	7
2.1. Spirit.....	7
2.2. Fair Play .....	8
2.3. Behavior .....	8
2.4. Mentors .....	8
2.5. Ethics and Integrity .....	9
2.6. Sharing.....	9
3. Field .....	9
3.1. Description.....	9
3.2. Floor.....	10
3.3. Line .....	10
3.4. Checkpoints .....	10
3.5. Speed Bumps, Debris, and Obstacles .....	11
3.6. Intersections and Dead Ends.....	11
3.7. Ramps.....	12
3.8. Seesaws.....	12

3.9. Evacuation Zone .....	13
3.10. Victims .....	13
3.11. Environmental Conditions .....	14
4. Robots.....	14
4.1. Terms and Definitions.....	14
4.2. Control.....	15
4.3. Construction .....	15
4.4. Team .....	16
4.5. Inspection.....	16
4.6. Violations .....	16
5. Play .....	17
5.1. Pre-game Practice .....	17
5.2. Humans.....	17
5.3. Start of Game .....	17
5.4. Scoring Run.....	18
5.5. Lack of Progress .....	18
5.6. Scoring.....	19
5.7. End of Game.....	21
6. Competition.....	22
6.1. Rounds & Scoring.....	22
7. Open Technical Evaluation .....	22
7.1. Documents.....	22
7.2. Sharing.....	23
8. Conflict Resolution .....	23
8.1. Referee and Referee Assistant.....	23
8.2. Rule Clarification .....	23
8.3. Special Circumstances.....	23

# 1. RoboCup General Rules

## 1.1. Team requirements

### 1.1.1. Team Size

**Minimum Team Size:** Teams must consist of at least 2 members.

**Maximum Team Size:**

- Rescue Leagues: 4 members.

**Shared Members and Robots:** No team member(s) or robot(s) may be shared between teams.

**Junior Mentor Requirement:** Each Junior team must have at least one Junior Mentor registered and attending with the team.

### 1.1.2. Age Requirements

**Junior Student Members:** Must be 7 to 12 years old as of July 1 of the competition year.

**Junior Mentors and Parent/Chaperones:** Must be 19 years or older as of the competition start date.

### 1.1.3. Team Members

**Entry Leagues:** RoboCupJunior Entry leagues and other "Primary" divisions (where minimum age may vary) are not run at the international competition but feature in many regions and SuperRegional tournaments.

**Technical Roles:** Every team member must have a defined technical role (mechanical/design, electrical/sensing, software etc.) and should be able to explain their role during technical judging.

## 1.2. Robot Requirements

### 1.2.1. Robot Communication

**Permitted Communication:** Communication between robots during gameplay is allowed as long as it uses the 2.4GHz spectrum and its power output does not exceed 100 mW EIRP under any circumstances.

**Responsibility:** Teams are responsible for managing their robot communication. Spectrum availability is not guaranteed.

**Component Communication:** Communication between components of the same robot is permitted under the general guidelines.

**League Adaptability:** Each league may modify the robot communication rules to ensure they meet their specific requirements.

## 1.2.2. Safety and Power Requirements

### Electrical Power:

- Robots must not use mains electricity.
- Maximum allowed voltage: 48V DC or 25V AC RMS.
- Voltage must be easily measured during inspections, and measuring points must be covered for safety or designed with safety considerations in place.

### Battery Safety:

- Lithium batteries must be stored in safety bags, and charging must be supervised by team members in competition areas.
- Teams must follow safety protocols, including battery fire handling and evacuation procedures.

### Robot Safety Design:

- **Power Management:** Secure batteries, safe wiring, and emergency stop functionality.
- **Mechanical Safety:** No sharp edges, pinch points, or other hazards. Actuators must be appropriate for the robot's size and function.
- **Hazardous Behavior:** Teams must report potentially dangerous robot behaviors at least two weeks before the event.

## 1.3. Documentation and Sharing requirements

### 1.3.1. Technical Description (See League Documentation)

#### Content:

- **Robotic Demonstration:** Show fully functional robot systems to highlight technical aspects.
- **Design Process:** Explain design choices and team problem-solving approaches.
- **Presentation:** Clear and high-quality, explaining innovative or unusual techniques.
- **Innovation & Sustainability:** Highlight new technologies and sustainable practices.

**Submission:** Guidelines will specify deadlines per league.

### 1.3.2. Sharing Team Resources

**Sharing:** Materials submitted by teams as part of the documentation submission will be shared on GitHub repositories for the leagues: <https://github.com/robocup-junior>

**Credit:** Teams must credit creators of external work and adhere to licensing rules. The focus should remain on personal growth and learning.

### 1.3.3. Plagiarism Guidelines

**External Code Use:** Teams are allowed to use external code but must credit the original creators.

**Learning Priority:** Teams should prioritize learning and not use complete solutions from others. Always pay attention to licensing rules.

## 1.4. Spirit and Behavior

### 1.4.1. Behavior

All participants are expected to behave themselves and be considerate and polite especially but not only towards other participants, volunteers, referees and organizers of all Junior and Major Leagues as well as the host venue.

### 1.4.2. Mentoring, Sponsorships and Component Reuse

Support from other teams, mentors, teachers, parents, sponsors, internet communities etc. is a core part of how teams learn and grow. To ensure fair competition and maximize learning it is required that none of the support they receive does the work of competing for the team. A good indication is the team's ability to explain not only what their robots' components do but also how they do it.

### 1.4.3. Onsite help

Teams are only allowed to receive help from other teams during the competition. To this end only student team members are allowed into the student work area except with temporary organizer permission. Anyone else is forbidden from touching the robots or their code, especially for repairs, changes, programming.

### 1.4.4. Violations

Teams that repeatedly conduct themselves in an unacceptable way may be disqualified from the tournament and asked to leave the venue.

## 2. Code of Conduct

### 2.1. Spirit

1. It is expected that all participants (students and mentors alike) respect the aims and ideals of RoboCupJunior as set out in our mission statement.
2. The volunteers, referees, and officials will act within the event's spirit to ensure the competition is competitive, fair, and, most importantly, fun.
3. **It is not whether you win or lose but how much you learn that counts!**

## 2.2. Fair Play

1. Robots that cause deliberate or repeated damage to the field will be disqualified.
2. Humans who cause deliberate interference with robots or damage the field will be disqualified.
3. It is expected that all teams aim to participate fairly.

## 2.3. Behavior

1. Each team is responsible for verifying the latest version of the rules on the RoboCupJunior Official website and additional clarifications/corrections on the official forum made by the RoboCupJunior Rescue Committee before the competition.
2. Participants should be mindful of other people and their robots when moving around the tournament venue.
3. Participants are not allowed to enter setup areas of other leagues or teams unless explicitly invited to do so by team members.
4. Teams will be responsible for checking updated information (schedules, meetings, announcements, etc.) during the event. The RoboCupJunior Rescue Committee will provide updated information on notice boards in the venue, the local competition website, or the RoboCupJunior website if possible.
5. Participants and their companions who misbehave may be asked to leave the venue and risk being disqualified from the tournament.
6. Referees, officials, tournament organizers, and local law enforcement authorities will enforce these rules equally to all participants.
7. Teams are expected to be at the venue early on the setup day as important activities will occur. These activities include but are not limited to registration, participation raffle, interviews, captains, and mentor's meetings, among others.

## 2.4. Mentors

1. Non-team members (mentors, teachers, parents and other family, chaperones, translators, and other adult team members) are not allowed in the student work area.
2. Mentors are not permitted to be involved in building, repairing, or programming their team's robots before and during the competition.
3. In the first instance, mentor interference with robots or referee decisions will result in a warning. If this behavior recurs, the team could face a possible elimination from the tournament.
4. Robots have to be the work of the students. Any robot that appears identical to another robot may be prompted for re-inspection.

## 2.5. Ethics and Integrity

1. Fraud and misconduct are not condoned. Fraudulent acts may include the following:
  - a. Mentors working on the software or hardware of student's robot(s) during the competition.
  - b. More experienced/advanced groups of students may provide advice but should not do the work for other groups. Otherwise, the team risks being disqualified.
2. RoboCupJunior reserves the right to revoke an award if fraudulent behavior is proven after the award ceremony occurs.
3. Suppose it is evident that a mentor intentionally violates the code of conduct and modifies and works on the student's robot(s) during the competition. In that case, the mentor will be banned from future participation in RoboCupJunior competitions.
4. Teams that violate the code of conduct can be disqualified from the tournament. Disqualifying a single team member from further participation in the tournament is also possible.
5. Referees, officials, tournament organizers, and local law enforcement authorities will give a team a warning in less severe cases of violations of the code of conduct. A team can be disqualified immediately without warning for severe or repeated violations of the code of conduct.

## 2.6. Sharing

1. The spirit of world RoboCup competitions is that teams should share technological and curricular developments with other participants after the tournament. Sharing furthers the mission of RoboCupJunior as an educational initiative.
2. The RoboCupJunior Rescue Committee may publish developments on the RoboCupJunior website after the event.
3. Participants are strongly encouraged to ask questions to their fellow competitors to foster a culture of curiosity and exploration in the fields of science and technology.

# 3. Field

## 3.1. Description

1. The field comprises modular tiles, which the organizers can use to make an endless number of courses for the robots to traverse.
2. The field will consist of 30 cm x 30 cm tiles with different patterns. The organizers will not reveal the final selection of tiles and their arrangement until the day of the competition. Competition tiles may be mounted on a hard-backing material of any thickness.
3. There will be a minimum of 8 tiles in a competition field, excluding the start and goal tiles.
4. There are different tile designs (teams can find examples under [Section 3.3, "Line"](#)).

## 3.2. Floor

1. The floor is white. The floor may be either smooth or textured (like linoleum or carpet) and may have steps of up to 3 mm in height between tiles. Due to the nature of the tiles, there may be a step or gaps in the construction of the field.
2. Competitors should be aware that tiles may be mounted on thick backing or raised off the ground, making it difficult to get back on a tile where the robot comes off the course. No provision will be made to assist robots that drive off a tile to get back onto the tile.
3. Robots must be designed to navigate under tiles that form bridges over other tiles. Tiles placed above other tiles will be supported by pillars at tile corners with a square cross-section of 25mm x 25mm, making each tile entrance/exit 25 cm. The minimum height (space between the floor and the ceiling) will be 25 cm.

## 3.3. Line

1. The black line, 1-2 cm wide, may be made with standard electrical insulating tape or printed onto paper or other materials. The black line forms a path on the floor. (The grid lines indicated in the drawings below are for reference only, and competitors can expect tiles to be added or omitted.)
2. Straight sections of the black line may have gaps with at least 5 cm of the straight line before each gap as measured from the shortest portion of the straight part of the line. The length of a gap will be no more than 20 cm.
3. The arrangement of the tiles and paths may vary between rounds.
4. The line will be at least 10 cm away from any edge of the field, walls, pillars to support ramps, seesaws, and obstacles that do not lie ahead of the robot's path.
5. The line will end with a goal tile with a 25mm x 300mm strip of red tape in the center of the tile, perpendicular to the incoming line.

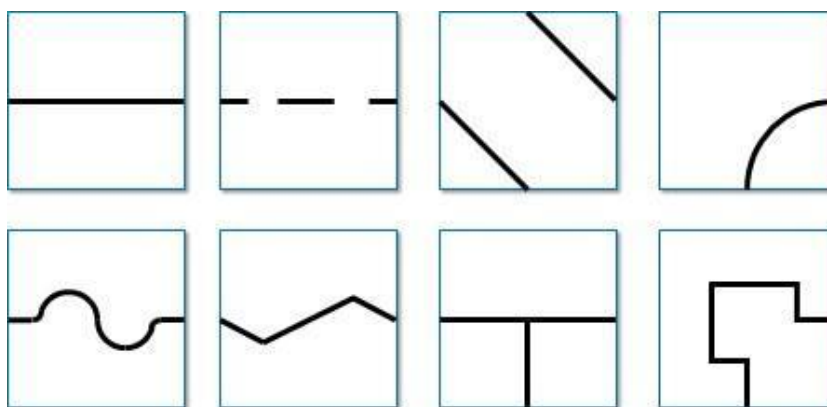

## 3.4. Checkpoints

1. A checkpoint is a tile in which a robot will be manually placed back when a lack of progress occurs.
2. Checkpoints will not be located on tiles with scoring elements.
3. The start tile is a checkpoint where the robot can restart.

4. A checkpoint marker is a marker that indicates for humans which tiles are checkpoints. A disk with 5 mm to 12 mm thickness and up to 70 mm in diameter has been used frequently. Still, it can be different depending on the organizer.
5. The field designers will predetermine the number of checkpoint markers and their locations.

### 3.5. Speed Bumps, Debris, and Obstacles

1. **The maximum size of a speed bump can be the size of a tile (30cm x 30cm)** and will have a height of 1 cm or less and be white. When the speed bump is placed over any black line, the overlap between the speed bump and the black line will be colored black. The organizers will fix speed bumps on the floor.
2. Speed bumps may also be placed anywhere in the evacuation zone. Speed bumps in evacuation zone are not scored.
3. Debris will have a maximum height of 3 mm. The organizers will not fix it to the floor. The debris consists of small materials such as toothpicks, small wooden dowels, etc.
4. Obstacles may include bricks, blocks, weights, and other large, heavy items. Obstacles will be at least 15 cm high and can be fixed to the floor.
5. An obstacle will not occupy more than one line or tile.
6. A robot is expected to navigate around obstacles. The robot may move obstacles, but obstacles may be very heavy or fixed to the floor. Obstacles will remain where they were moved to, even if that prevents the robot from proceeding.
7. Obstacles will not be placed closer than 25 cm from the edge of the field (including edges of tiles that are elevated by ramps) and inclined tiles.
8. In the evacuation zone, obstacles may be placed anywhere with a minimum of 10 cm clearance from the wall. Obstacles in the evacuation zone are not scored.

### 3.6. Intersections and Dead Ends

1. The organizers can place intersections anywhere except in the evacuation zone.
2. Intersections markers are green and 25 mm x 25 mm in dimension. They indicate the direction of the path the robot should follow.
3. The robot should continue straight ahead if there is no green marker at an intersection.
4. A dead end is when there are two green marks before an intersection (one on each side of the line); in this case, the robot should turn around.
5. The intersections are always perpendicular but may have 3 or 4 branches.
6. Intersection markers will be placed just before the intersection. See the images below for possible scenarios.

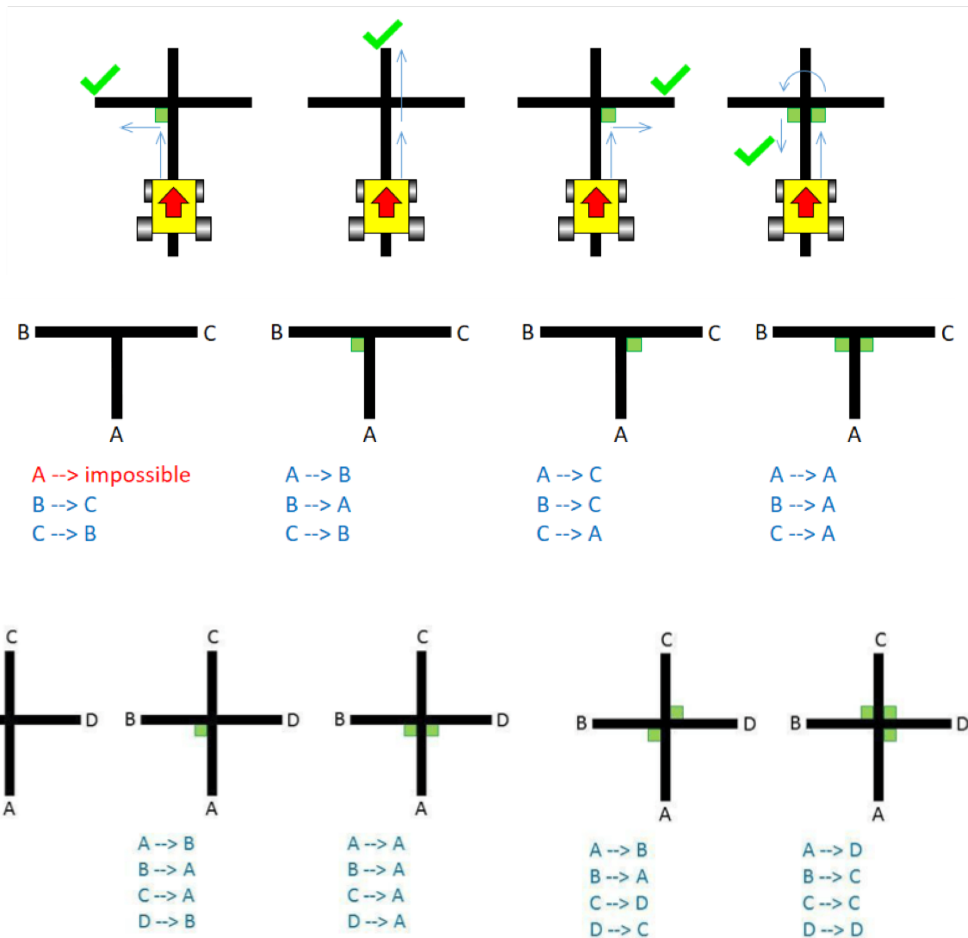

### 3.7. Ramps

1. Tiles will be used as ramps to allow the robots to 'climb' up and down from different levels.
2. Ramps will not exceed an incline of 25 degrees from the horizontal.
3. More than one tile may be used to build one ramp up or down.
4. **The ramp points will be awarded for each individual ramp tile instead of the entire ramp.**
5. The line along the ramps can contain gaps, speed bumps, intersections, obstacles and debris.
6. **The ramp must NOT have a drop-off immediately following a rise section, creating a peak-line structure or viceversa.**

### 3.8. Seesaws

1. A seesaw is a tile that can pivot around a hinge in the center of a regular tile.
2. The seesaw will have an incline less than 20 degrees when tilted to one side.
3. The seesaw tile will have a straight line with no scoring elements present.

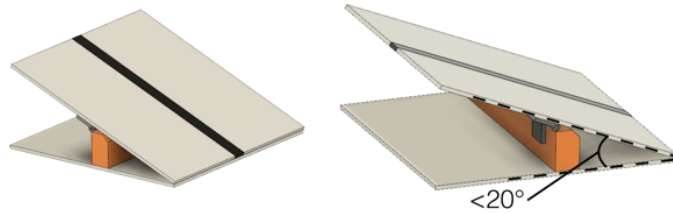

### 3.9. Evacuation Zone

1. The black line will end at the entrance of the evacuation zone.
2. The black line will begin again at the exit of the evacuation zone.
3. The evacuation zone is 120 cm by 90 cm with walls around the four sides at least 10 cm high and of any color (except for red, green, and black). The posts joining the walls of the evacuation zone can be of any color (except for red, green, and black).
4. At the entrance to the evacuation zone, there is a 25 mm × 250 mm strip of reflective silver tape on the floor.
5. At the exit of the evacuation zone, there is a 25 mm × 250 mm strip of black tape on the floor.
6. The organizers may place an obstacle inside the evacuation zone. In the evacuation zone, organizers may put the obstacle anywhere with a minimum of 10 cm clearance from the wall. Obstacles in the evacuation zone are not scored.
7. Safe evacuation points are defined by right-angled triangles with sides of 30 cm x 30 cm.
  - a. There will be one red evacuation point where the dead victim must be placed by the robot and,
  - b. There will be one green evacuation point where the living victims must be placed by the robot.
8. The evacuation points are red and green triangles with 6 cm walls and a hollow center.
9. The referee can place the evacuation points in any non-entry/exit corners in the evacuation zone.
10. After a Lack of Progress, the referee may place the evacuation points in new corners.
11. The organizers will fix the evacuation points to the floor. Still, teams should be prepared for slight movements in the evacuation points.



### 3.10. Victims

1. Organizers may locate victims anywhere on the floor of the evacuation zone.
2. A victim represents a person and is in the form of a 4-5 cm diameter sphere with an off-center center of mass and a maximum weight of 80 g.

3. There are two types of victims:
  - a. Dead victims are black and not electrically conductive.
  - b. Living victims are silver, reflect light, and are electrically conductive.
4. Teams may choose to preload a single live victim onto their robot. If the preloaded live victim falls off the robot at any point in the run, it must be left where it lands and must not be preloaded back onto the robot.
5. Organizers will locate the victims randomly in the evacuation zone. There will be precisely two live victims and one dead victim placed in the evacuation zone if no preload is done.
6. If teams choose to preload a live victim, there will be precisely one live victim preloaded onto the robot. There will be precisely one live victim and one dead victim placed in the evacuation zone.

## 3.11. Environmental Conditions

1. The environmental conditions at a tournament may differ from those at home. Teams must come prepared to adjust their robots to the conditions at the venue.
2. Lighting and magnetic conditions may vary in the rescue field.
3. The field may be affected by magnetic fields (e.g., under-floor wiring and metallic objects). Teams should prepare their robots to handle such interference.
4. The field may be affected by unexpected lighting interference (e.g., camera flash from spectators). Teams should prepare their robots to handle such interference.
5. All measurements in the rules have a tolerance of  $\pm 10\%$ .

# 4. Robots

## 4.1. Terms and Definitions

1. **Tool:** The term "tool" is a comprehensive concept that encompasses both hardware and software components essential for the operation of robots. These can include physical components such as sensors, actuators, or controllers, as well as software elements like algorithms or libraries.
2. **Calibration:** Calibration refers to the process in which a team intervenes to adjust or fine-tune the settings of a tool.
3. **Development:** Development refers to activities aimed at creating new solutions, technologies, or systems, as well as enhancing existing ones through innovation and creative problem-solving. In this case, for example, calibration is not considered development since it involves fine-tuning or configuring an existing system without introducing new features, technological advancements, or innovations.
4. Tools are allowed as long as they are developed by the team or when they cannot independently complete a task, or a part of a task, that enables the robot to earn points by sending a signal to the controller without further development (e.g., color sensors, cameras, or libraries necessary for sensor operation).

5. Tools which are not developed by the team, which can independently complete a task, or a part of a task, which enables the robot to earn points by sending a signal to the controller without further development (e.g., line-following sensors, AI cameras, OCR libraries) are prohibited.

## 4.2. Control

1. Robots must be controlled autonomously. Using a remote control, manual control, or passing information (by external sensors, cables, wirelessly, etc.) to the robot is not allowed.
2. Robots must be started manually by the team captain.
3. Any pre-mapped type of dead reckoning (movements preprogrammed based on known locations or placement of features in the field) is prohibited.
4. Robots must not damage any part of the field in any way.

## 4.3. Construction

1. Any robot kit or building blocks, either available on the market or built from raw hardware, may be used as long as the design and construction of the robot are primarily and substantially the students' original work.
2. Teams are not permitted to use commercially produced robot kits or sensors components specifically designed or marketed to complete any single primary task of RoboCupJunior Rescue. Robots that do not comply will face immediate disqualification from the tournament. If there is any doubt, teams should consult the RoboCupJunior Rescue Committee before the competition.
3. Only lasers from classes 1 and 2 are allowed for the safety of participants and spectators. The organizers will check this during the inspection. Teams using lasers must have the datasheet of the laser and submit them before the competition and be able to show them during the competition.
4. Robots may incur damage by falling off the field, making contact with another robot, or contacting field elements. The RoboCupJunior Rescue Committee cannot anticipate all potential situations where damage to the robot may occur. Teams should ensure that all active elements on a robot are adequately protected with resistant materials. For example, teams must protect electrical circuits from all human contact and direct contact with other robots and field elements.
5. When batteries are transported, moved, or charged, it is strongly recommended that safety bags be used. Reasonable efforts should be made to ensure that robots avoid short circuits and chemical or air leaks.
6. **Robots must be equipped with a handle that is to be used to pick them up during the scoring run.**
7. **Robots must be equipped with a single physical binary switch/button (with exception of buttons that are a part of commercial controller), clearly visible to the referee, for starting the robot at the beginning of the run and when a lack of progress occurs. Procedure performed after LoP occurs can only include this button and at most one more switch for cutting the power. Team has to notify the referee about their LoP procedure before each scoring run, and only this procedure is allowed to be performed after a LoP.**
8. **Robots like drones or hovercrafts are prohibited in the challenge due to safety reasons.**

## 4.4. Team

1. Each team must have only one robot on the field.
2. Each team must comply with the [RoboCupJunior General Rules](#) regarding the number of members and each member's age.
3. Each team member must explain their work and have a specific technical role.
4. A student can be registered on only one team across all RoboCupJunior leagues/sub-leagues.
5. A team can only participate in one league/sub-league across all RoboCupJunior leagues/sub-leagues.
6. Team members may compete in Rescue Line twice (2 international events). After competing in Rescue Line twice, they must move to another RoboCupJunior sub-league.
7. Mentors/parents are not allowed to be with the students during the competition. The students will have to govern themselves (without a mentor's supervision or assistance) during the long stretch of hours at the competition.

## 4.5. Inspection

1. A panel of referees will scrutinize the robots before the start of the tournament and at other times during the competition to ensure that they meet the constraints described in these rules.
2. Using a robot similar to another team's robot from a previous year or the current year is illegal.
3. The team's responsibility is to have their robot re-inspected if modified at any time during the tournament.
4. Students will be asked to explain their robot's operation to verify that its construction and programming are their own work.
5. Students will be asked about their preparation efforts. The RoboCupJunior Rescue Committee may request them to answer surveys and participate in videotaped interviews for research purposes.
6. All teams must complete a web form before the competition to allow referees to prepare better for the interviews. The RoboCupJunior Rescue Committee will provide instructions on submitting the form to the teams at least 4 weeks before the competition.
7. All teams have to submit their source code before the competition. The organizers will not share the source code with other teams without the team's permission. The organizers will request permission at the registration.

## 4.6. Violations

1. Any violations of the inspection rules will prevent the offending robot from competing until modifications are made, and the robot passes inspection.
2. Teams must make modifications within the schedule of the tournament, and teams cannot delay tournament play while making modifications.
3. Suppose a robot fails to meet all specifications (even with modifications). In that case, it will be disqualified from that game (but not from the tournament).

4. No mentor assistance is allowed during the competition. (See [Section 2, “Code of Conduct”](#))
5. Any rule violations may be penalized by disqualification from the tournament or the game or result in a loss of points at the discretion of the referees, officials, or RoboCupJunior Rescue Committee.

## 5. Play

### 5.1. Pre-game Practice

1. When possible, teams will have access to practice fields for calibration and testing throughout the competition.
2. Whenever there are dedicated independent fields for competition and practice, it is at the organizers' discretion if testing is allowed on the competition fields.

### 5.2. Humans

1. Teams should designate one of their members as 'captain' and another as 'co-captain'. Only these two team members will be allowed access to the competition fields unless directed by a referee. Only the captain can interact with the robot during a scoring run.
2. The captain can move the robot only when they are told to do so by a referee.
3. Other team members (and any spectators) within the vicinity of the competition field must stand at least 150 cm away from the field unless directed by a referee.
4. No one is allowed to touch the fields intentionally during a scoring run.
5. All pre-mapping activities will immediately disqualify the robot for the round. Pre-mapping is the act of humans providing the robot with information about the field (e.g., location of obstacles, entrance to the evacuation zone, number of tiles after the evacuation zone, etc...) before the game.

### 5.3. Start of Game

1. Each team has a maximum of 8 minutes for a game. The game includes the time for calibration and the scoring run.
2. Calibration is taking sensor readings and modifying the robot's programming to accommodate such sensor readings. Calibration does not count as pre-mapping.
3. The scoring run is defined as the time when the robot is moving autonomously to navigate the field, and the referee will record the scores.
4. A game begins at the scheduled starting time, whether or not the team is present or ready. Start times will be posted around the venue.
5. Once the game has begun, the robot is not permitted to leave the competition area.
6. Teams may calibrate their robot in as many locations as desired on the field, but the clock will continue to run. Robots are not permitted to move on their own while calibrating.

7. Once a team is ready to start a scoring run, the team must notify the referee. To start a scoring run, the robot is placed on the start tile of the course, as indicated by the referee. Once a scoring run has begun, no more calibration is permitted, including changing code/code selection.
8. Teams may choose not to calibrate the robot and immediately start the scoring run instead.
9. Individual tiles, obstacles, and other scoring elements may be removed, added, or changed when the robot starts moving; to prevent teams from pre-mapping the layout of the fields. These changes may happen based on a die rolled by the referee or with another method of randomization announced by the organizers. For a particular field during a round, the referee will ensure the difficulty of the field will be kept similar, and the maximum points are constant.

## 5.4. Scoring Run

1. Robots will start behind the joint of the start tile and the subsequent tile along the course. The referee will check the correct placement.
2. Modifying the robot during a scoring run is prohibited, which includes remounting parts that have fallen off.
3. Any parts the robot loses intentionally or unintentionally will be left in the field until the run is over. **This includes the live victim preloaded onto the robot, if teams choose to do so.** Team members and referees cannot move or remove elements from the field during a scoring run.
4. Teams cannot give their robot any information about the field. A robot is supposed to recognize the field elements by itself.
5. The robot must follow the course completely to enter the evacuation zone and then out of the evacuation zone towards the goal tile.
6. The robot has reached a tile when more than half the robot is within that tile when viewed from above and robot is actively following the line at that point in time.

## 5.5. Lack of Progress

1. A lack of progress occurs when:
  - a. a team captain declares a lack of progress.
  - b. a robot loses the black line without regaining it by the next tile in the sequence (see figures at the end of the section).
  - c. a robot reaches a line that is not in the intended sequence.
2. If a lack of progress occurs, the robot must be positioned on the previous checkpoint tile facing the path towards the goal tile and checked by the referee.
3. After a lack of progress, only the LoP procedure explained to the referee before the run start is allowed to be performed (see [Section 4.3, "Construction"](#)).
4. There is no limit to the lack of progress within a round.
5. After three failed attempts to reach a checkpoint, a robot is allowed to proceed to the next checkpoint.
  - a. The team captain may make further attempts at the course to earn additional points from scoring

elements that have not already been earned before reaching the next checkpoint.

6. Suppose a lack of progress occurs in the evacuation zone. In that case, all victims that are not held by the robot (including ones that have rolled) will remain in their current position. Victims that are held by the robot (that are not preloaded) will be placed roughly on the robot's location when a lack of progress occurs in the evacuation zone. Suppose a lack of progress occurs as the robot exits the evacuation zone while carrying victims. In that case, the victims (that are not preloaded) will be randomly placed in the evacuation zone. The preloaded victim (if teams choose to do so), will remain on the robot if the victim was still held by the robot as the lack of progress occurred.
7. Any seesaws ahead of the robot's path can be moved in a favorable direction when a lack of progress is called.

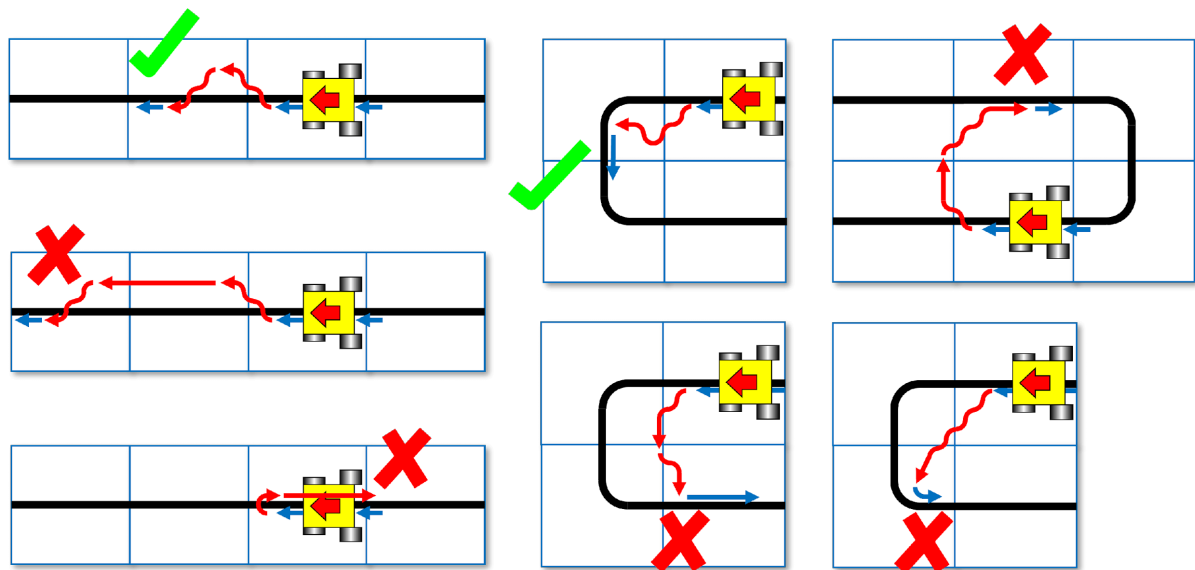

## 5.6. Scoring

1. A robot is awarded points for successfully navigating each tile with hazards (gaps in the line, speed bumps, intersections, dead ends, ramps, obstacles, and seesaws). Points are awarded per hazard when the robot has reached the next tile in sequence. A ramp as a hazard accounts for all inclined tiles that make up one ramp. Point allocations are 10 points per tile with one or more gaps, 10 points per tile with one or more speed bumps, 10 points per intersection/dead end, 10 points per ramp, 20 points per obstacle, and 20 points per seesaw.
2. Failed attempts at navigating hazards in the field are defined as a Lack of Progress (see [Section 5.5, "Lack of Progress"](#)).
3. When a robot reaches a checkpoint tile or stops on the goal tile, it will earn points for each tile it has passed since the previous checkpoint. The points per tile depend on how many attempts the robot has made:
  - 1st attempt = 5 points/tile
  - 2nd attempt = 3 points/tile
  - 3rd attempt = 1 point/tile
  - Beyond the 3rd attempt = 0 points/tile

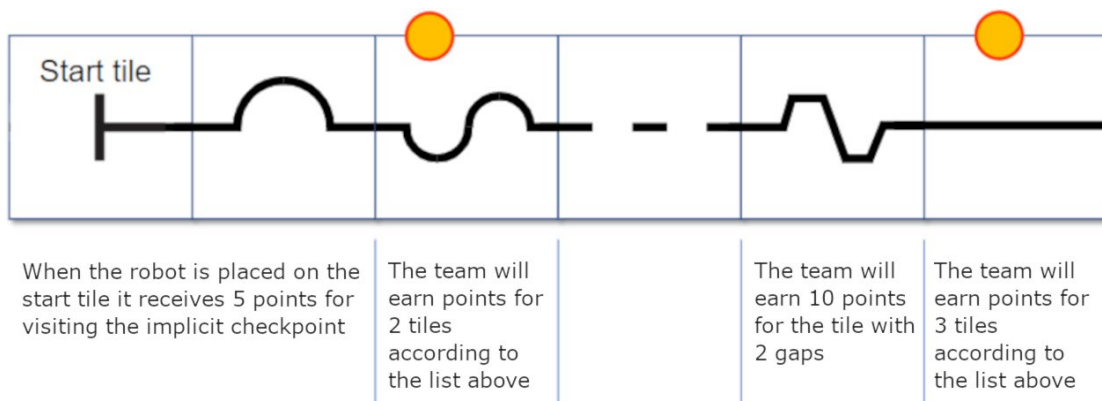
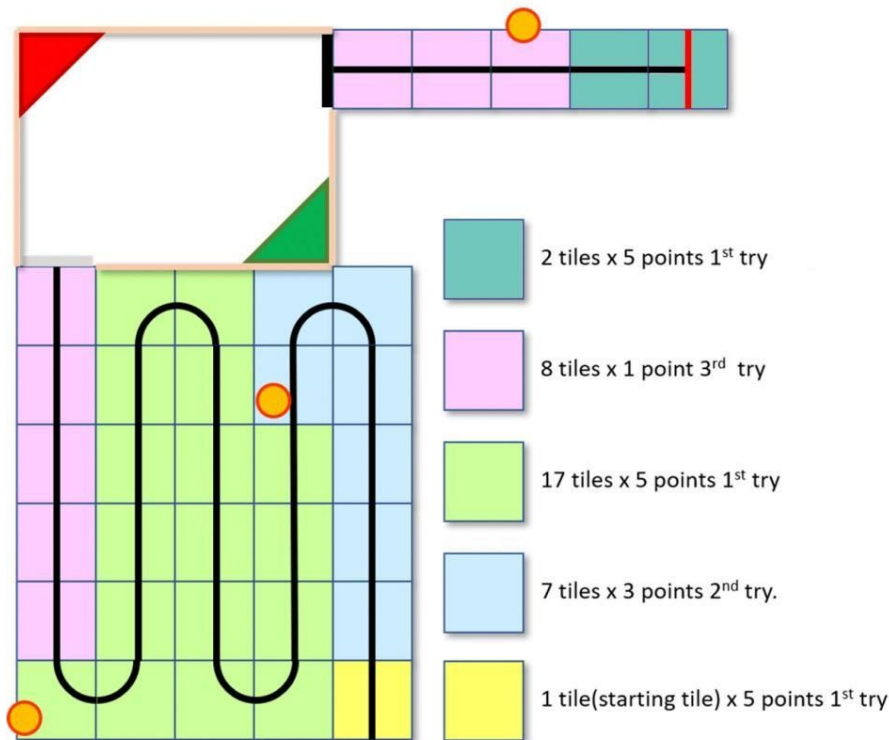

4. Each gap, speed bump, intersection, dead end, ramp, obstacle, and seesaw can only be scored once per intended direction through the course. Points are not awarded for subsequent attempts through the course.
5. The referees will not count any hazards in the evacuation zone towards additional points.
6. Successful victim rescue (SVR): Robots are awarded multipliers for successfully rescuing victims. A successful victim rescue occurs when the victim is entirely moved into the designated evacuation point, and no part of the robot can be in contact with the victim. When the referee determines there has been a successful victim rescue, the referee will remove the victim from the evacuation point to allow more victims to be evacuated. The multipliers are allocated as such:
  - (SLVR) =  $\times 1.4$  per successful rescue of a living victim.
  - (SDVR) =  $\times 1.4$  per successful rescue of the dead victim if both living victims have already been successfully evacuated.
7. Only the victims placed by the robot at the appropriate evacuation point will be awarded multipliers.

8. When a lack of progress occurs between checkpoints (or a checkpoint and the goal) containing an evacuation zone, each of the (SVR) obtained multipliers will be deducted:
  - a. (EZLP) =  $-0.05 \times$  (number of lack of progresses in the area containing an evacuation zone)
9. Multipliers earned for successful victim rescues will never be lower than 1.25.
10. The evacuation zone multiplier is, thus, combined as:

$\begin{aligned} &(\text{EVACUATION ZONE MULTIPLIER}) = \\ &((\text{SLVR})+(\text{EZLP}))_1 \\ &\times ((\text{SLVR})+(\text{EZLP}))_2 \\ &\times ((\text{SDVR})+(\text{EZLP})) \end{aligned}$	<table border="0"> <tr> <td style="padding-right: 10px;"> </td> <td>Successful rescue of the first living victim</td> </tr> <tr> <td style="padding-right: 10px;"> </td> <td>Successful rescue of the second living victim</td> </tr> <tr> <td style="padding-right: 10px;"> </td> <td>Successful rescue the dead victim</td> </tr> </table>		Successful rescue of the first living victim		Successful rescue of the second living victim		Successful rescue the dead victim
	Successful rescue of the first living victim						
	Successful rescue of the second living victim						
	Successful rescue the dead victim						

11. An exit bonus is awarded when the robot has reached the goal tile and has completely stopped for more than 5 seconds (this time is included in the total 8 minutes). The exit bonus is a non-negative number and is given by

$(\text{EXIT BONUS}) = 60 - 5 \times (\text{number of total lack of progress})$
---

12. The multipliers from successful evacuations are multiplied by the score obtained from the line tracing course.

$(\text{FIELD SCORE}) = (\text{LINE TRACING SCORE} + \text{EXIT BONUS}) \times (\text{EVACUATION ZONE MULTIPLIER})$
---

## 5.7. End of Game

1. A team may elect to stop the game early at any time. In this case, the team captain must indicate the team's desire to terminate the game to the referee. The team will be awarded all points earned up to the call for the end of the game. The referee will stop the time at the end of the game, which will be recorded as the game time.
2. The game ends when:
  - a. the 8 minutes of allowed game time expires
  - b. the team captain calls the end of the game
  - c. the robot reaches the goal tile and completely stops for 5 seconds

## 6. Competition

This chapter outlines the structure of an international RoboCupJunior Rescue competition. The competition format and the inclusion of elements like rubrics based scoring, Technical Challenges and the SuperTeam Challenge may vary in local, regional and super-regional competitions. Please refer to the respective organiser for details.

### 6.1. Rounds & Scoring

1. The competition will consist of multiple rounds.
2. The field score for every round will be normalized with the score of the best team of that round:

$$(\text{NORMALIZED FIELD SCORE}) = (\text{FIELD SCORE}) / (\text{BEST FIELD SCORE})$$

3. The normalized field scores will be used to calculate the mean:

$$(\text{MEAN OF NORMALIZED FIELD SCORES}) = (\text{SUM OF NORMALIZED FIELD SCORES}) / (\text{NUMBER OF ROUNDS})$$

4. Ties in scoring will be resolved based on the mean of normalized field scores.

## 7. Open Technical Evaluation

### 7.1. Documents

1. Teams must provide documents that explain their work. Each invention must be supported by concise but clear documentation. The documents must show precise steps towards the creation of the invention.
2. The deadline for delivering the documents will be before the first day of the competition through an online form. The exact date will be made known to the teams.
3. Documents must include one Technical Description Paper (TDP). Teams should be prepared to explain their work.
4. All teams must submit their TDP before the competition. The TDP is a public document that will be shared with the community. **The competition organizer will ask the team to fill out the web form or ask to submit a PDF file. All teams must strictly follow the guidance on the web form or, in the case of PDF submissions, strictly follow the template provided. If a team does not follow this guidance / template (including but not limited to the different sections, fonts, sizes and lengths) the score for the document will be 0 and is not going to be evaluated.** A template for the TDP and rubrics are available on the [RoboCupJunior Rescue Community Website](#).

## 7.2. Sharing

1. Teams are encouraged to review others' TDPs and presentations.
2. Teams awarded certificates must post their documents and presentation online when the RoboCupJunior Rescue Committee asks.

# 8. Conflict Resolution

## 8.1. Referee and Referee Assistant

1. All decisions during gameplay are made by the referee or the referee assistant, who are in charge of the field, persons, and objects surrounding them.
2. During gameplay, the decisions made by the referee or the referee assistant are final.
3. After gameplay, the referee will ask the captain to sign the score sheet. Captains will be given a maximum of 1 minute to review the score sheet and sign it. By signing the score sheet, the captain accepts the final score on behalf of the entire team. In case of further clarification, the team captain should write their comments on the score sheet and sign it.

## 8.2. Rule Clarification

1. If any rule clarification is needed, please contact the [International RoboCupJunior Rescue Committee](#) through the [RoboCupJunior Forum](#).
2. If necessary, even during a tournament, a rule clarification may be made by members of the [International RoboCupJunior Rescue Committee](#).

## 8.3. Special Circumstances

1. If particular circumstances, such as unforeseen problems or capabilities of a robot occurs, rules may be modified by the RoboCupJunior Rescue Committee Chair in conjunction with available committee members, even during a tournament.
2. Suppose team captains/mentors do not attend the team meetings to discuss problems, and the resulting rule modifications described at [1.](#) In that case, the organizers will understand that they agreed and were aware of the changes.